

Solving Problems: Intelligent Search

Instructor: B. John Oommen

Chancellor's Professor

Life Fellow: IEEE; Fellow: IAPR

School of Computer Science, Carleton University, Canada

The primary source of these notes are the slides of Professor Hwee Tou Ng from Singapore. **I sincerely thank him for this.**

Heuristic Search

- Problem with DFS and BFS: No way to **guide** the search
- Solution can be anywhere in tree.
- In the worst case all possible states will be traversed
- One “solution” to this problem
 - Probe the search space
 - Where is the final state **likely** to be
- This of course will be problem specific
- A function is usually created that evaluates:
 - How **good** the current solution is
 - This function is used to help **guide** the search process
- This guided search called a **Heuristic Search**

A Heuristic

- Derived from the Greek: *heuriskein*: “to find”; “to discover”
- Has been used (and is sometimes still used) to mean:
 - “A process that may solve a given problem, but offers no guarantees of doing so” Newall, Shaw, & Simon 1963
- Heuristics can also be thought of as a “Rule of Thumb”
- Can refer to any technique that improves **average-case** but not necessarily **worst-case** performance
- Here: A function that provides an **estimate of solution cost**

Advantage of Heuristics

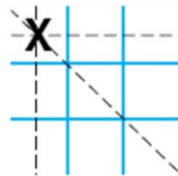
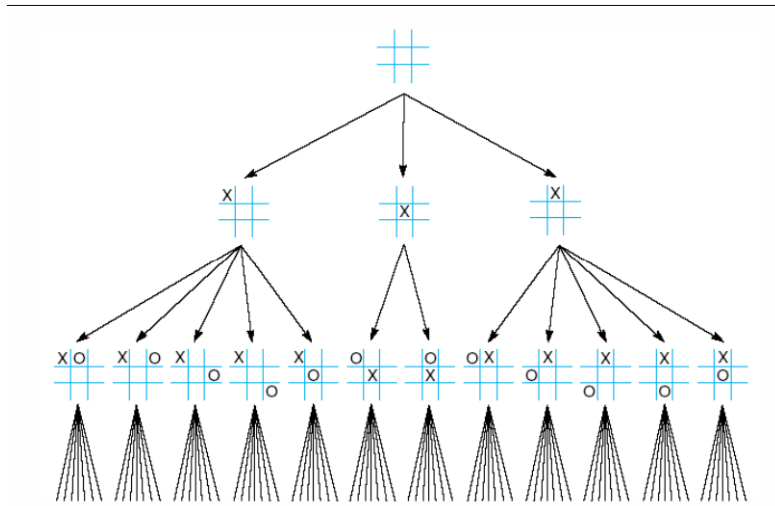

Three wins through a corner square

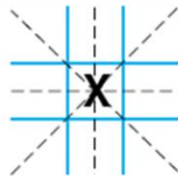

Four wins through the center square

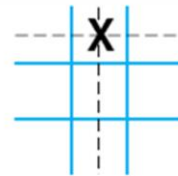

Two wins through a side square

Advantage of Heuristics: Reduced State Space

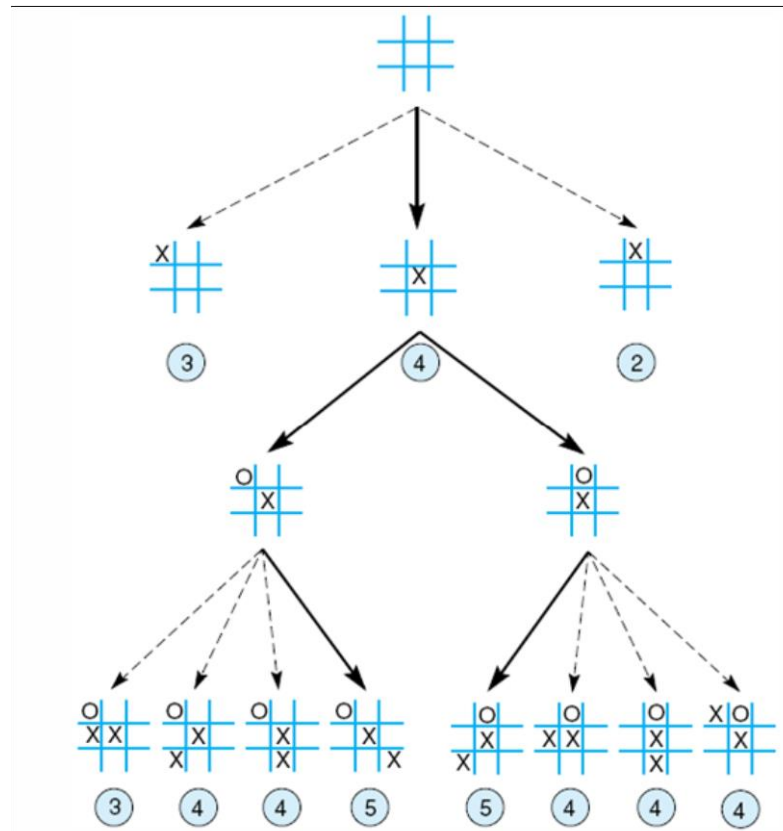

Performance of Heuristics

- Performance of several heuristics...

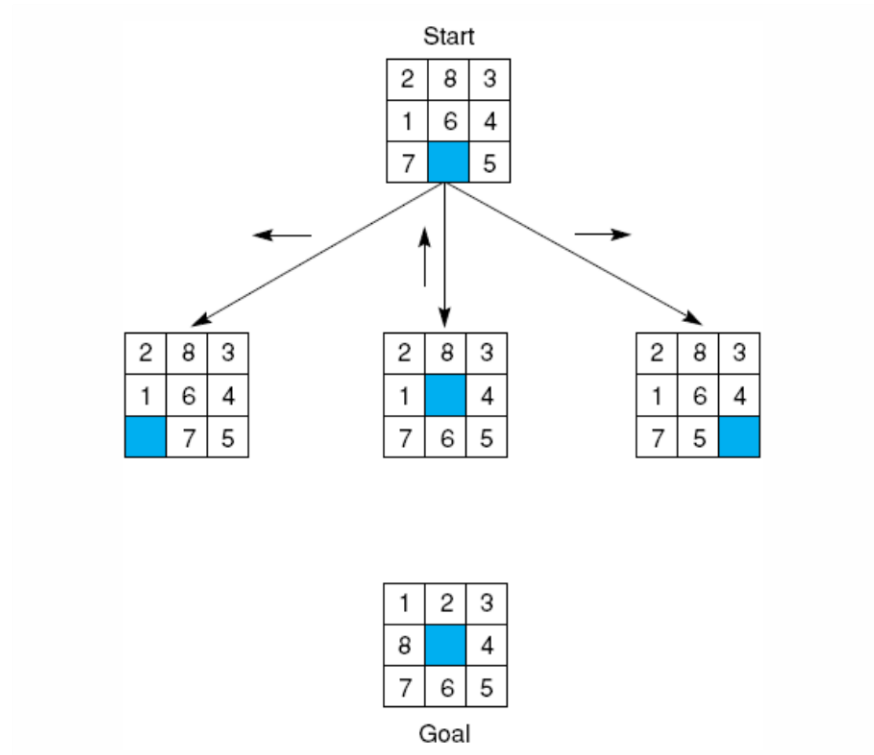

Possible Heuristics

- **Count the tiles out of place:**
 - State with fewest tiles out of place is closer to the desired goal
- **Distance Summation:**
 - Sum all the distance by which the tiles are out of place
 - State with the shortest distance is closer to the desired goal
- **Count reversal Tiles:**
 - If two tiles are next to each other, and the goal requires their position to be swapped. The heuristic takes this into account by evaluating the expression $(2 * \text{number of direct tiles reversal})$

<table border="1"> <tr><td>2</td><td>8</td><td>3</td></tr> <tr><td>1</td><td>6</td><td>4</td></tr> <tr><td>7</td><td>7</td><td>5</td></tr> </table>	2	8	3	1	6	4	7	7	5	5	6	0
2	8	3										
1	6	4										
7	7	5										
<table border="1"> <tr><td>2</td><td>8</td><td>3</td></tr> <tr><td>1</td><td>7</td><td>4</td></tr> <tr><td>7</td><td>6</td><td>5</td></tr> </table>	2	8	3	1	7	4	7	6	5	3	4	0
2	8	3										
1	7	4										
7	6	5										
<table border="1"> <tr><td>2</td><td>8</td><td>3</td></tr> <tr><td>1</td><td>6</td><td>4</td></tr> <tr><td>7</td><td>5</td><td>7</td></tr> </table>	2	8	3	1	6	4	7	5	7	5	6	0
2	8	3										
1	6	4										
7	5	7										
	Tiles out of place	Sum of distances out of place	2 x the number of direct tile reversals									

1	2	3
8	7	4
7	6	5

Goal

Best-first Search

- **Idea:** use an **evaluation function** $f(n)$ for each node
 - Estimate of “desirability”
 - Expand most desirable unexpanded node
- **Implementation:**
Order the nodes in fringe in decreasing order of desirability
- **Special cases:**
 - Greedy best-first search
 - A* search

Best-first Search

- Combine BFS and DFS using a **heuristic function**
- Expand the branch that has the best evaluation under the heuristic function
- Similar to hill climbing (move in the best direction)
- But can go back to “discarded” branches

Best-first Search Algorithm

- Initialize **OPEN** to initial state, **CLOSED** to Empty list
- Until a Goal is found or no nodes left in **Open** do:
 - Pick the best node in **OPEN**
 - Generate its successors, place node in **CLOSED**
 - For each successor do:
 - If not previously generated (not found in **OPEN** or **CLOSED**)
 - Evaluate
 - Add to **OPEN**

OPEN: Generated nodes who's children have not been evaluated yet

» Implemented as a priority queue (heap structure)

CLOSED: Nodes that have been examined

» Used to see if a node has been visited if searching a graph instead of a tree

» Same as in DFS and BFS

Example of BestFS

Step 1

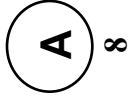

Step 2

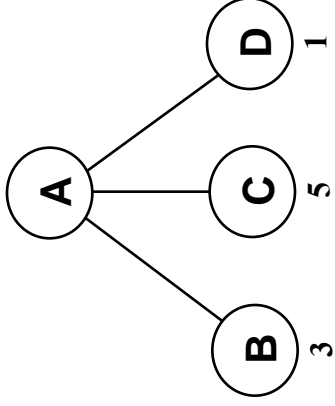

Step 3

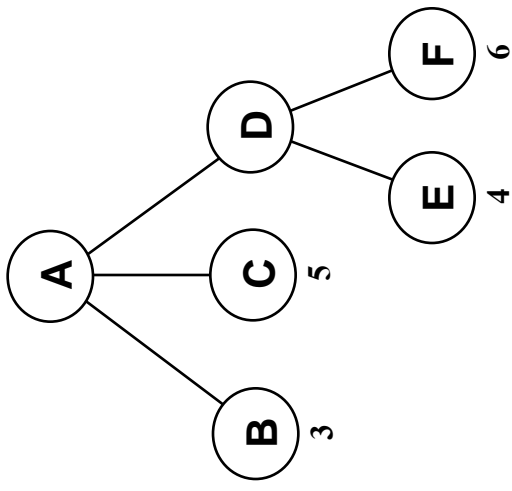

Step 4

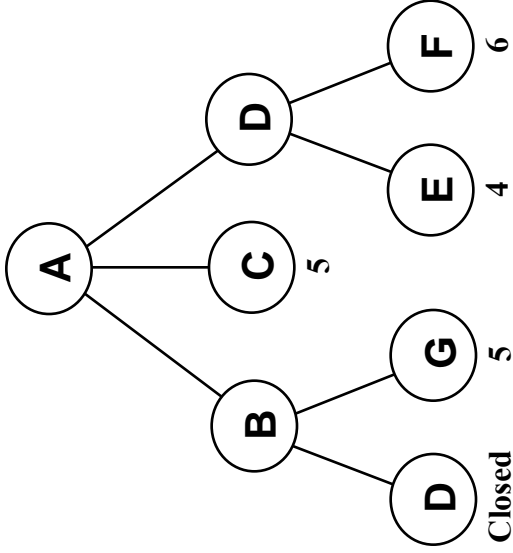

Step 5

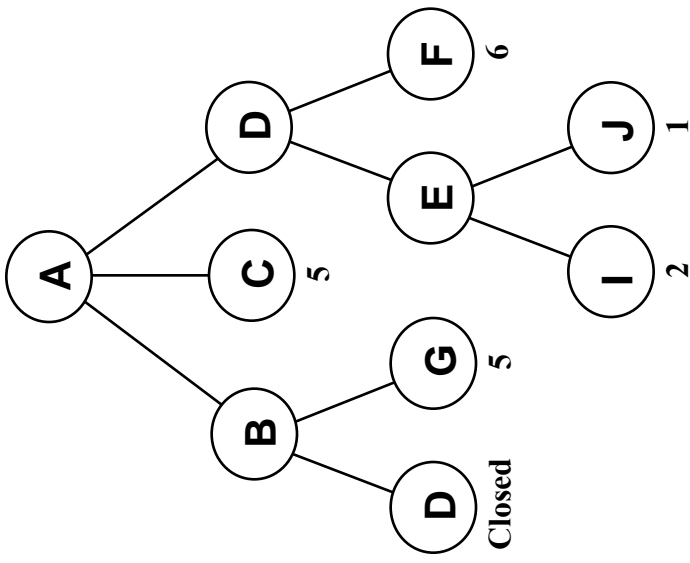

Greedy Best-first Search

- Evaluation function $f(n) = h(n)$ (**heuristic**)
- An **estimate** of cost from n to *goal*
- $h_{SLD}(n)$ = straight-line distance from n to Bucharest
- Greedy Best-first Search expands the node that **appears** to be closest to goal

Romania: Step Costs in Km

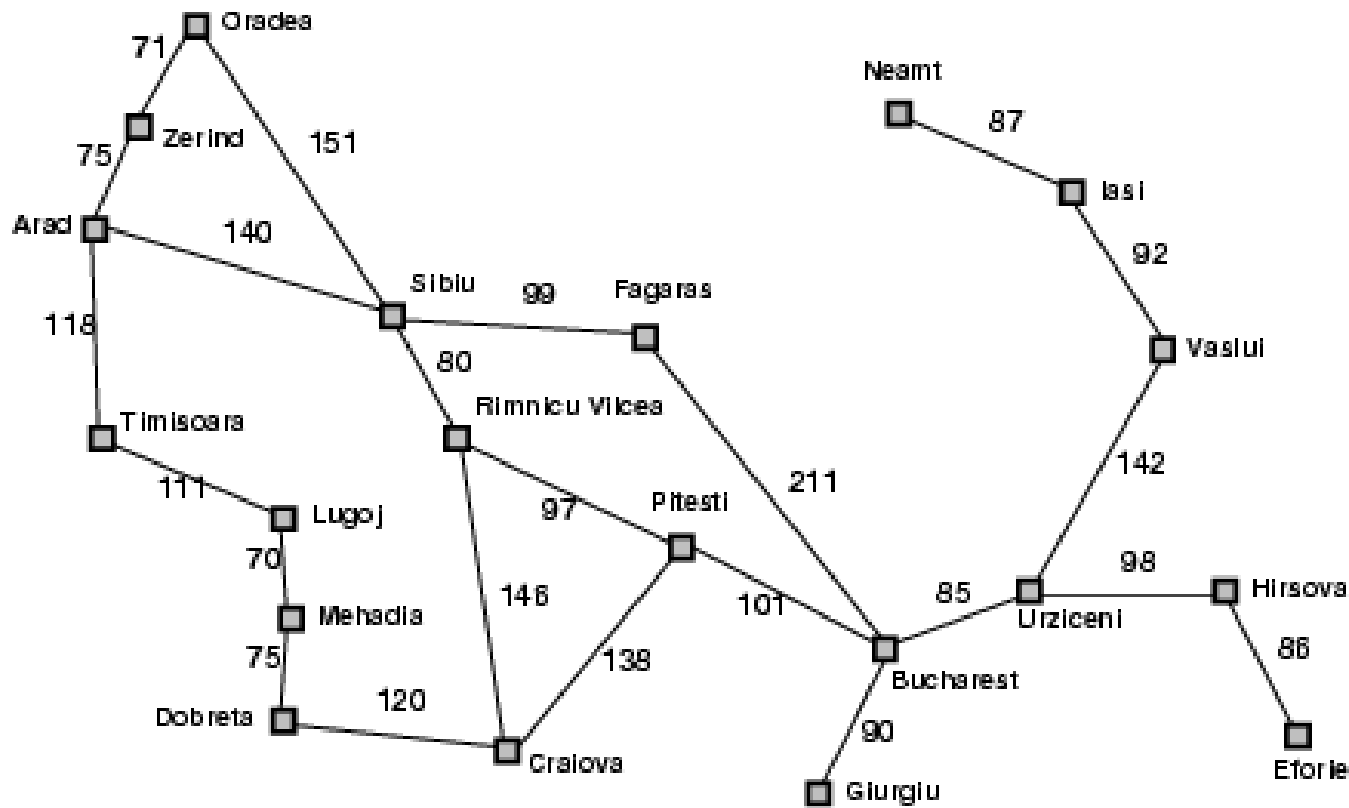

Straight-line distance
to Bucharest

Arad	366
Bucharest	0
Craiova	160
Dobreta	242
Eforie	161
Fagaras	176
Giurgiu	77
Hirsova	151
Iasi	226
Lugoj	244
Mehadia	241
Neamt	234
Oradea	380
Pitesti	10
Rimnicu Vilcea	193
Sibiu	253
Timisoara	329
Urziceni	80
Vaslui	199
Zerind	374

Example: Greedy Best-first Search



Example: Greedy Best-first Search



Example: Greedy Best-first Search

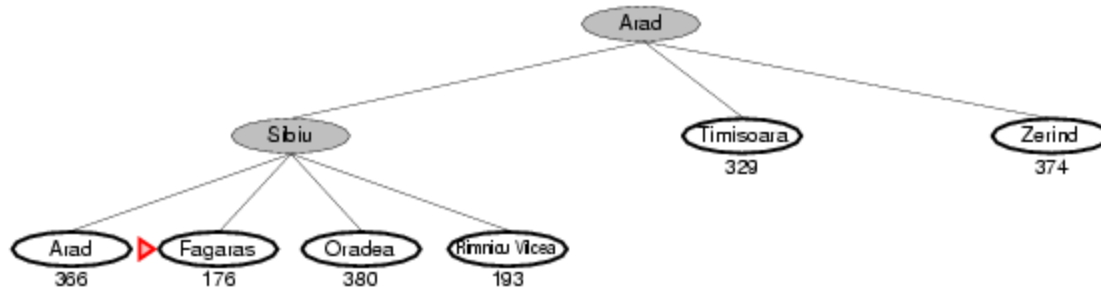

Example: Greedy Best-first Search

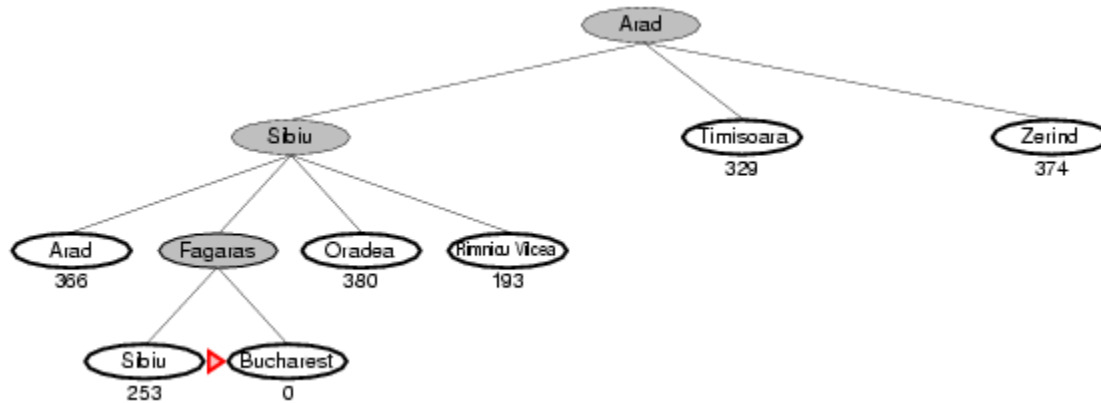

Properties: Greedy Best-first Search

- **Complete?**

- No – can get stuck in loops
- lasi → Neamt → lasi → Neamt →

- **Time?**

- $O(b^m)$
- But a good heuristic can give dramatic improvement

- **Space?**

- $O(b^m)$
- Keeps all nodes in memory

- **Optimal?**

- No

A* Search

- A modification of the Best-first Search
- Used when searching for the **Optimal** path
- Idea: Avoid expanding paths that are “expensive”
- The heuristic function **f(S)** is broken into two parts:
- Evaluation function $f(n) = g(n) + h(n)$
 - $g(n)$ = Cost **so far** to reach n
 - $h(n)$ = **Estimated cost** from n to goal
 - $f(n)$ = Estimated total cost of path through n to goal

How A* Works

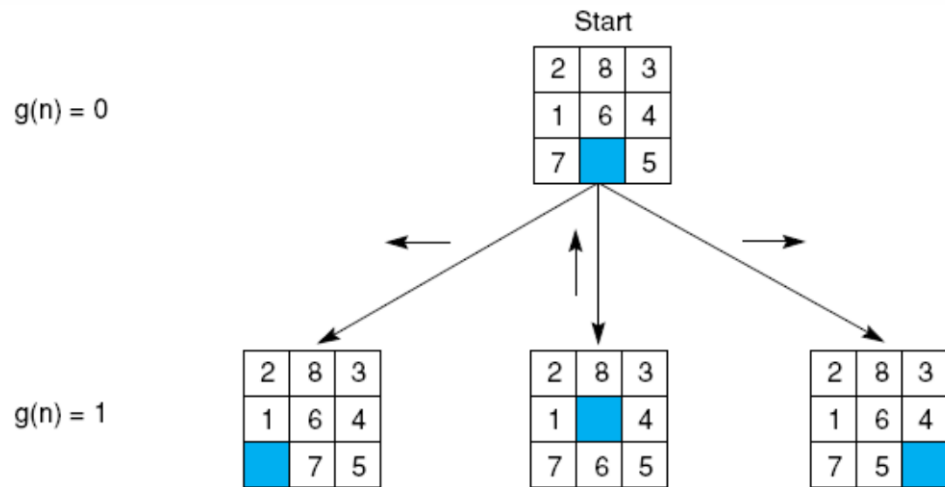

Values of $f(n)$ for each state,

6

4

6

where:

$$f(n) = g(n) + h(n),$$

$g(n)$ = actual distance from n
to the start state, and

$h(n)$ = number of tiles out of place.

1	2	3
8		4
7	6	5

Goal

How A* Works

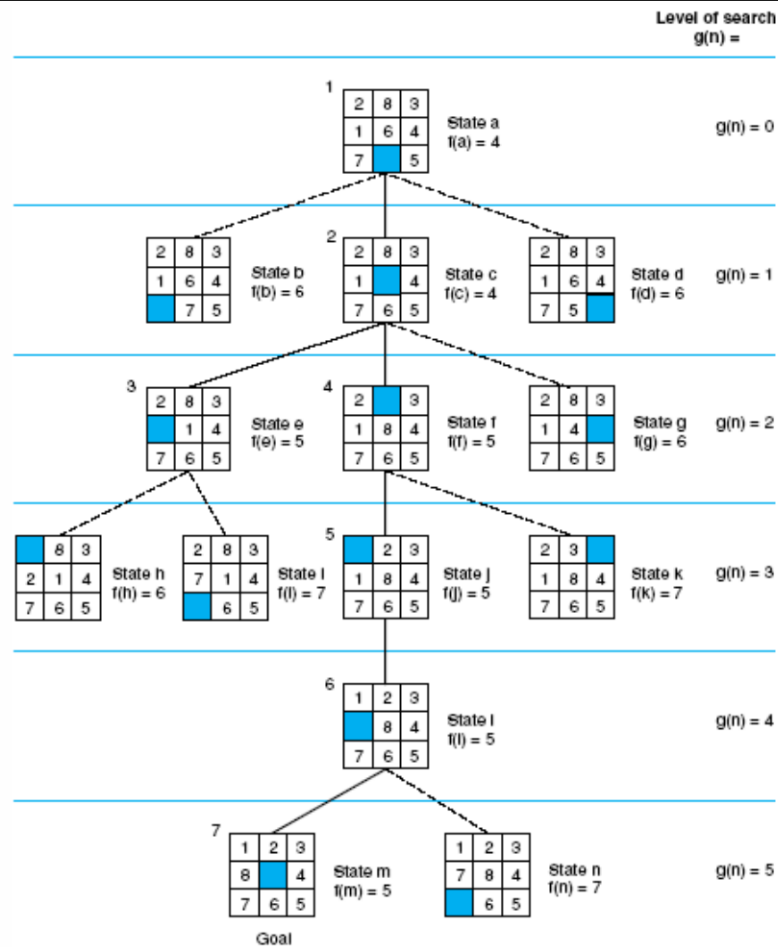

A* Algorithm

- Initialize **OPEN** to initial state
- Until a Goal is found or no nodes left in **OPEN** do:
 - Pick the best node in **OPEN**
 - Generate its successors (recording the successors in a list);
 - Place in **CLOSED**
 - For each successor do:
 - If not previously generated (not found in **OPEN** or **CLOSED**)
 - Evaluate, add to **OPEN** , and record its parent
 - If previously generated (found in **OPEN** or **CLOSED**), and if the new path is better then the previous one
 - Change parent pointer that was recorded in the found node
 - If parent changed
 - Update the cost of getting to this node
 - Update the cost of getting to the children
 - Do this by recursively “regenerating” the successors using the list of successors that had been recorded in the found node
 - Make sure the priority queue is reordered accordingly

Properties of A*

- Becomes simple Best-first Search if $g(S) = 0$ for every S
- When a child state is formed
 - $g(S)$ can be incremented by 1
 - Or be weighted based on the production system operator generated the state
- Is **Breadth-first Search** if $g += 1$ per generation and $h=0$ always

Properties of A*

- If h is the **perfect** estimator of the distance to the Goal (say, H)
 - A* will immediately find and traverse the optimal path to the solution
 - Will need **NO** backtracking
- If h never **overestimates** H
 - A* will find an optimal path to the solution (if it exists)
 - Problem lies in **finding** such an h

h Under/Over Estimates H

h Underestimates H

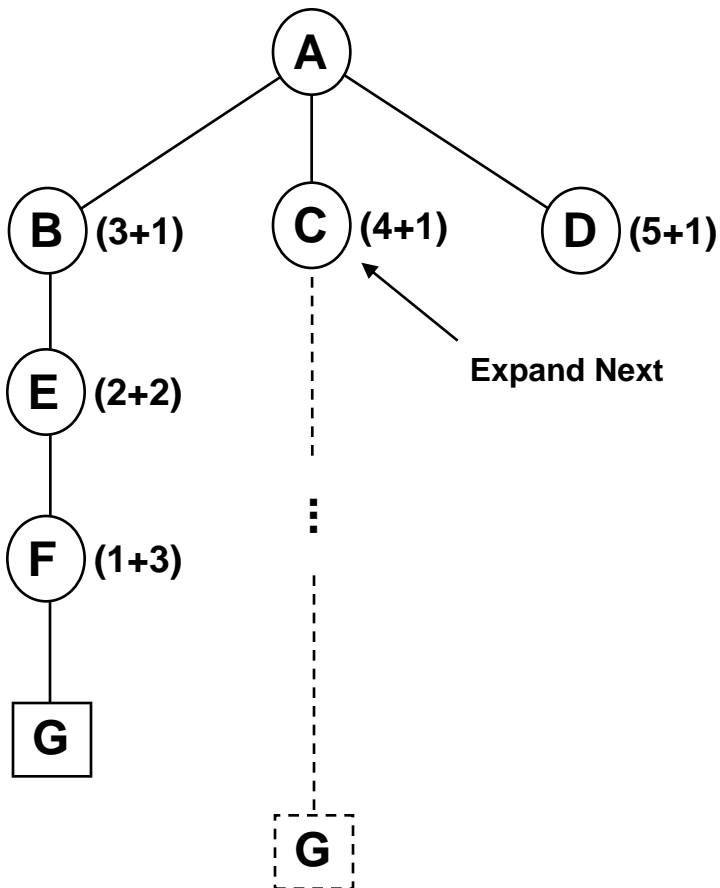

h Overestimates H

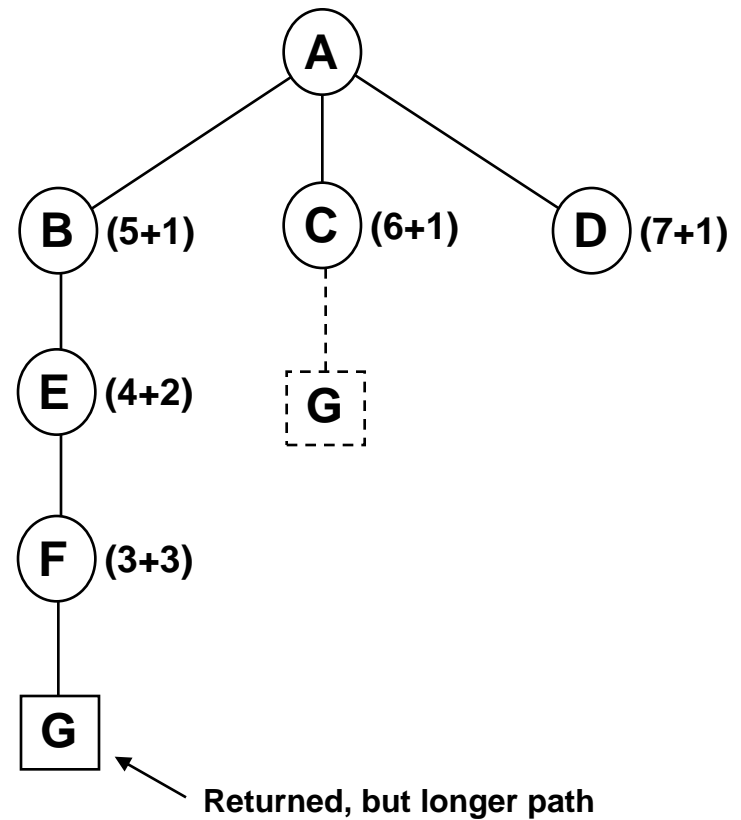

Goal is G

Importance of Heuristic Function

- If we have the exact Heuristic Function H
 - The search gets solved optimally
- Exact H is usually **very hard** to find
 - In many cases it would be a solution to an NP problem in polytime
 - Which is probably not possible to compute in less time than it would take to do the exponential sized search
- Next best: Guarantee h underestimates distance to the Sol^n .
 - A minimum path to the Goal is then guaranteed

Heuristic Function vs. Search Time

- The better the heuristic, the less searching
 - Improves the average time complexity
- However, to compute such a heuristic
 - Can figure out a good algorithm
 - Usually costs computation cycles
 - This could be used to process more nodes in the search
 - Trade-off between complex heuristics vs. more search done

Example: A* Search

▶ Arad
366=0+366

Example: A* Search



Example: A* Search

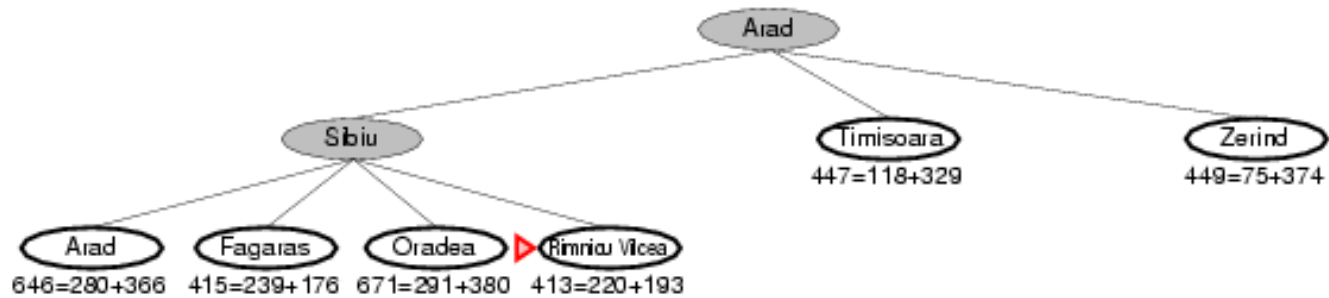

Example: A* Search

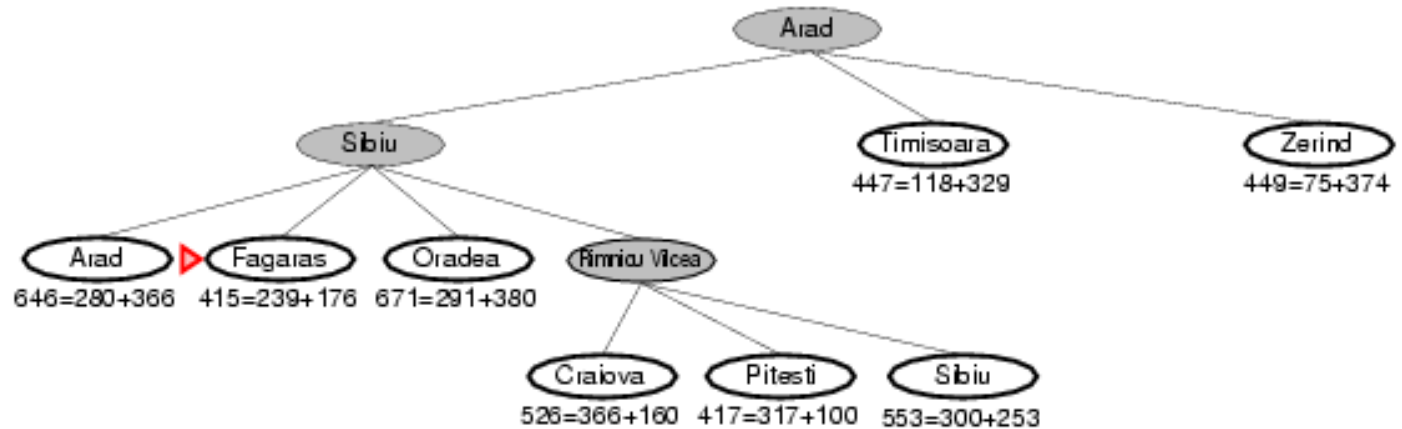

Example: A* Search

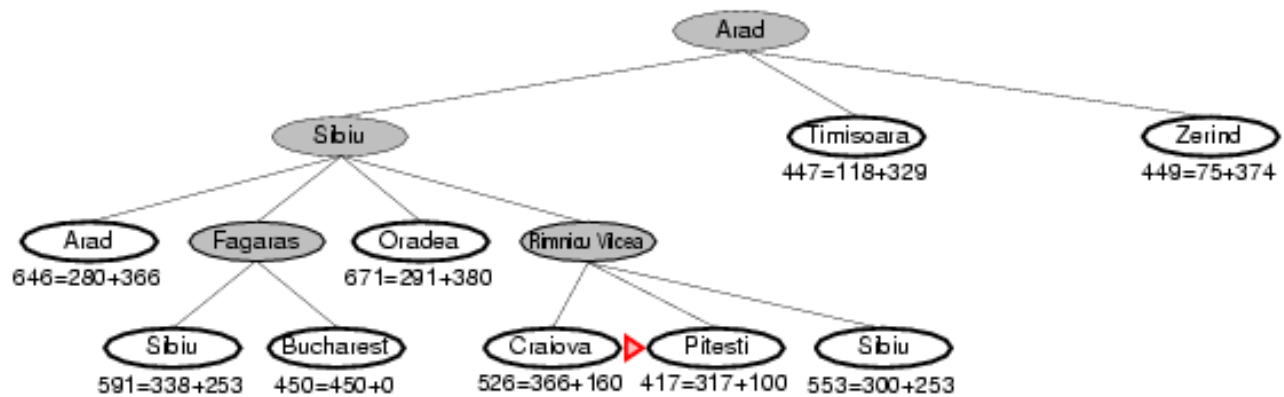

Example: A* Search

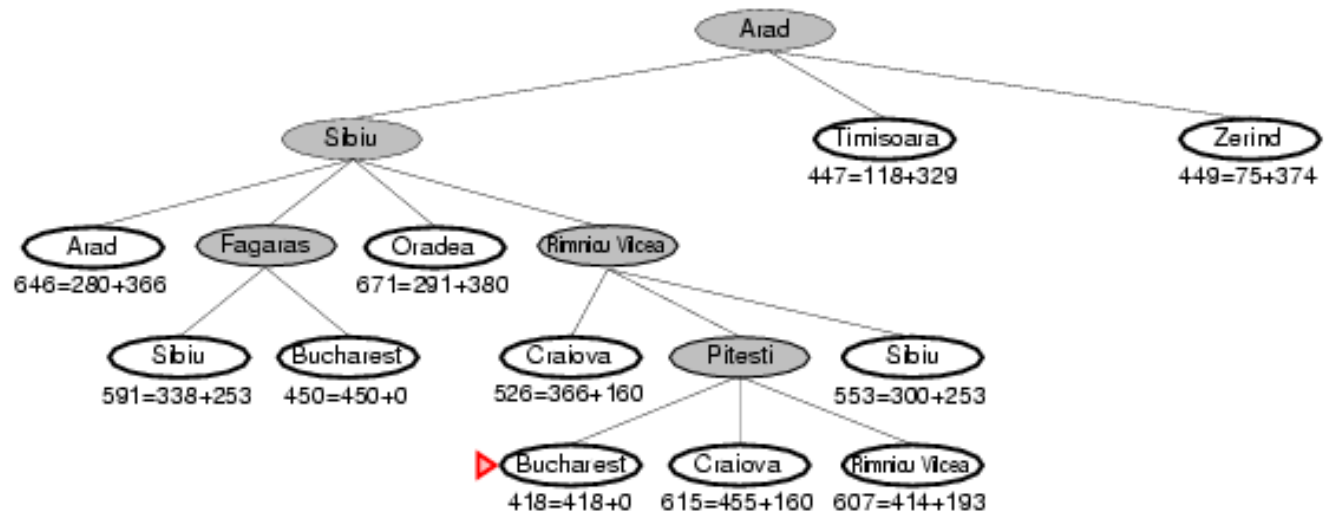

Other Example: A* Search

- Please see the other Powerpoint in the folder...

Admissible Heuristics

- A heuristic $h(n)$ is **Admissible** if for every node n , $h(n) \leq h^*(n)$, where $h^*(n)$ is the **true** cost to reach the goal state from n .
- An admissible heuristic **never overestimates** the cost to reach the goal, i.e., it is **optimistic**
- Example: $h_{SLD}(n)$ (never overestimates the actual road distance)
- **Theorem:** If $h(n)$ is admissible, A^* using TREE-SEARCH is **optimal**

Proof: Optimality of A^*

- Suppose some suboptimal goal G_2 has been generated and is in the fringe.
- Let n be an unexpanded node in the fringe such that n is on a shortest path to an optimal goal G .

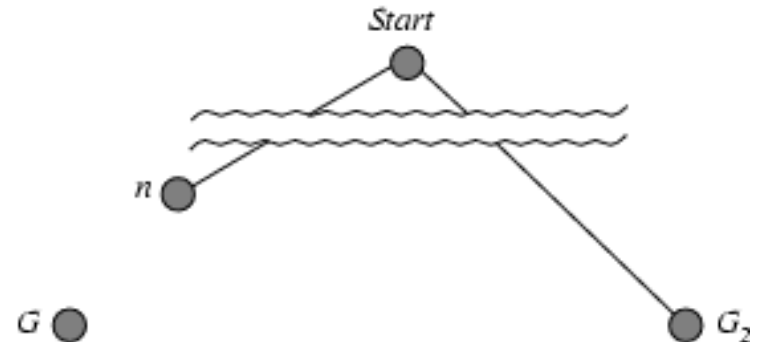

- $f(G_2) = g(G_2)$ Since $h(G_2) = 0$
- $g(G_2) > g(G)$ Since G_2 is suboptimal (2)
- $f(G) = g(G)$ Since $h(G) = 0$ (3)
- $f(G_2) = g(G_2) > g(G)$ (from (2)) = $f(G)$ (from (3))
- $f(G_2) > f(G)$ From above

Proof: Optimality of A*

- Suppose some suboptimal goal G_2 has been generated and is in the *fringe*.
- Let n be an unexpanded node in the *fringe* such that n is on a shortest path to an optimal goal G .

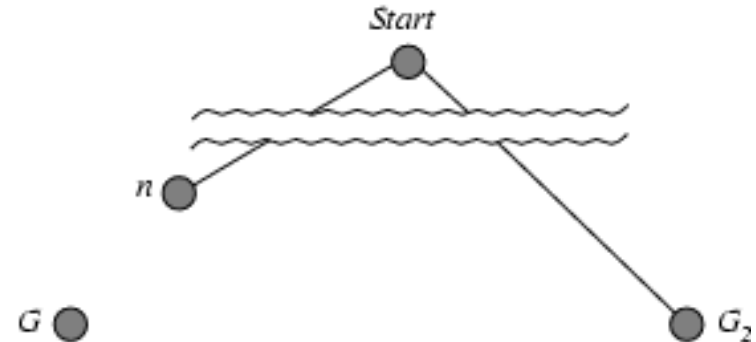

- $f(G_2) > f(G)$
- $h(n) \leq h^*(n)$
- $g(n) + h(n) \leq g(n) + h^*(n)$
- $f(n) \leq f(G)$

Hence $f(G_2) > f(n)$.

From above

Since h is admissible

Thus A* will never select G_2 for expansion

Consistent Heuristics

- A heuristic is **consistent** if for every node n , every successor n' of n generated by any action a ,

$$h(n) \leq c(n,a,n') + h(n') \quad (4)$$

- If h is consistent, we have

$$\begin{aligned} f(n') &= g(n') + h(n') \\ &= g(n) + c(n,a,n') + h(n') \quad (\text{By (4)}) \\ &\geq g(n) + h(n) \\ &= f(n) \end{aligned}$$

- i.e., $f(n)$ is non-decreasing along any path.
- Theorem:** If $h(n)$ is consistent, A* using GRAPH-SEARCH is optimal.
- Essentially since: At the very end – $h(G) = 0$.

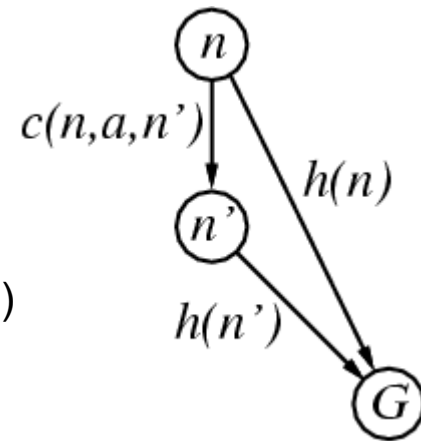

Optimality of A*

- A* expands nodes in order of increasing f value
- Gradually adds " f -contours" of nodes
- Contour i has all nodes with $f=f_i$, where $f_i < f_{i+1}$

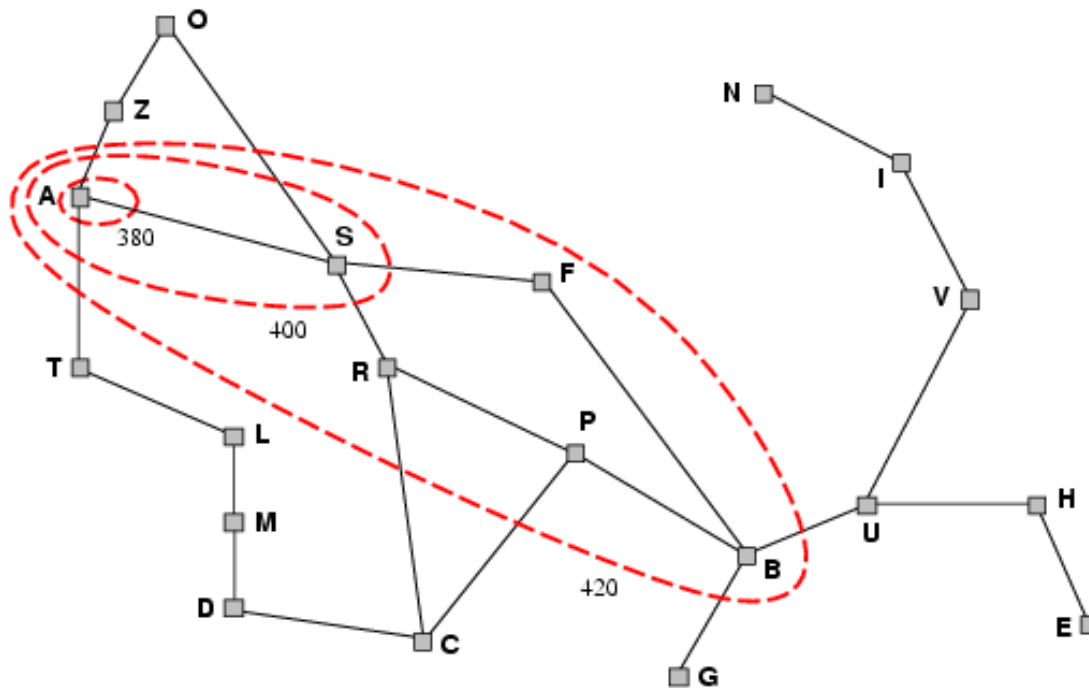

Properties of A*

- **Complete?**
 - Yes (unless there are infinitely many nodes with $f \leq f(G)$)
- **Time?**
 - Exponential
- **Space?**
 - Keeps all nodes in memory
- **Optimal?**
 - Yes

Admissible Heuristics

The 8-puzzle:

- $h_1(n)$ = number of misplaced tiles
- $h_2(n)$ = total Manhattan distance
(i.e., No. of squares from desired location of each tile)

7	2	4
5		6
8	3	1

Start State

	1	2
3	4	5
6	7	8

Goal State

- $h_1(S) = ?$ 8
- $h_2(S) = ?$ 3+1+2+2+2+3+3+2 = 18

Dominance

- If $h_2(n) \geq h_1(n)$ for all n (both admissible)
- then h_2 **dominates** h_1
- h_2 is better for search

- Typical search costs (average number of nodes expanded):
 - $d=12$ IDS = 3,644,035 nodes
 $A^*(h_1) = 227$ nodes
 $A^*(h_2) = 73$ nodes
 - $d=24$ IDS = too many nodes
 $A^*(h_1) = 39,135$ nodes
 $A^*(h_2) = 1,641$ nodes

Relaxed Problems

- A problem with fewer restrictions on the actions is called a **relaxed problem**
- The cost of an optimal solution to a relaxed problem is an admissible heuristic for the original problem
- If the rules of the 8-puzzle are relaxed so that a tile can move **anywhere**, then $h_1(n)$ gives the shortest solution
- If the rules are relaxed so that a tile can move to **any adjacent square**, then $h_2(n)$ gives the shortest solution

Beam Search

- Same as BestFS and A* with one difference
- Instead of keeping the list OPEN unbounded in size, Beam Search fixes the size of OPEN
- OPEN only contains the best K evaluated nodes

Beam Search

- If **new node** considered is not better than any in **OPEN**, and **OPEN** is full, **new node** is not added
- If **new node** is to be inserted in the middle of the priority queue, and **OPEN** is full, **drop** the node at the end of **OPEN** (the one with the **least** priority)

Local Beam Search

- Keep track of *k states* rather than just one
- Start with *k* randomly generated states
- At each iteration, *all the successors of all *k* states* are generated
- If any one is a goal state, stop; else select the *k* best successors from the complete list & repeat.

Local Search Algorithms

- In many optimization problems, the **path** to the goal is irrelevant; the goal state itself is the solution
- State space = set of “complete” configurations
- Find configuration satisfying constraints, e.g., n-queens
- In such cases, we can use **local search algorithms**
- keep a single “current” state, try to improve it

Hill Climbing Search

- “Like climbing Everest in thick fog with amnesia”

```
function HILL-CLIMBING(problem) returns a state that is a local maximum
  inputs: problem, a problem
  local variables: current, a node
                  neighbor, a node

  current ← MAKE-NODE(INITIAL-STATE[problem])
  loop do
    neighbor ← a highest-valued successor of current
    if VALUE[neighbor] ≤ VALUE[current] then return STATE[current]
    current ← neighbor
```

Example: n -queens

- Put n queens on an $n \times n$ board
- No two queens on the same row, column, or diagonal

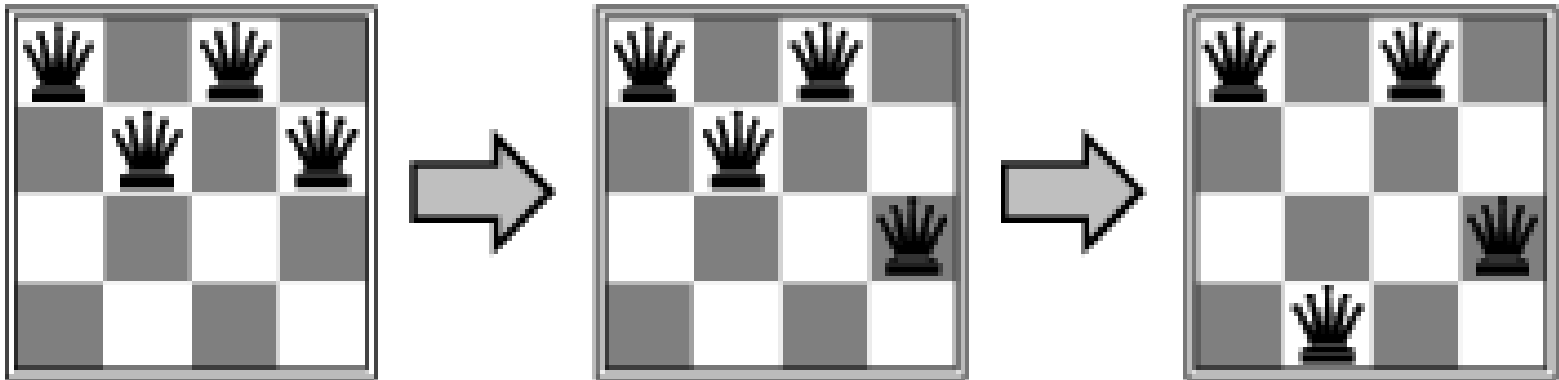

Example: 8-queens

18	12	14	13	13	12	14	14
14	16	13	15	12	14	12	16
14	12	18	13	15	12	14	14
15	14	14	♙	13	16	13	16
♙	14	17	15	♙	14	16	16
17	♙	16	18	15	♙	15	♙
18	14	♙	15	15	14	♙	16
14	14	13	17	12	14	12	18

- h = No. of pairs of queens that are attacking each other, either directly or indirectly
- $h = 17$ for the above state

Hill-climbing Search: 8-queens problem

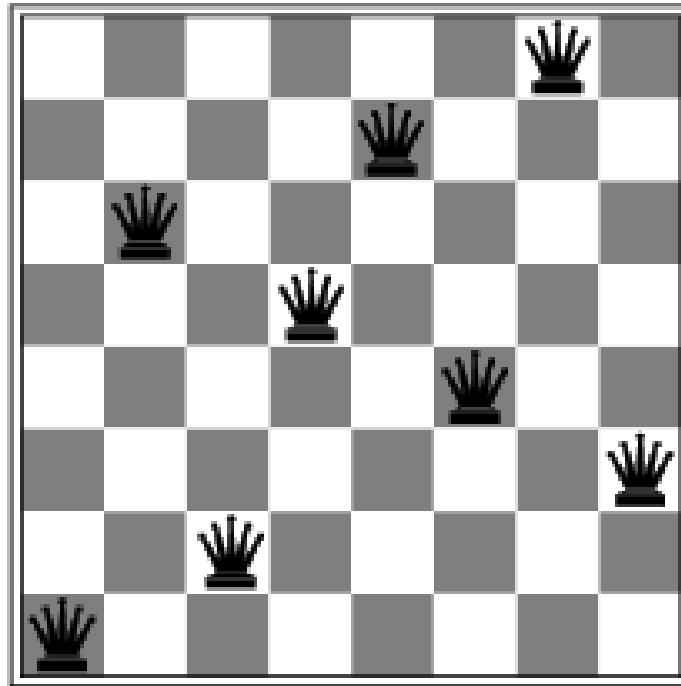

- A local minimum with $h = 1$

Hill Climbing Search

Simple-Hill-Climber (S)

- Evaluate S; If Goal state return and quit
- Loop until a solution is found or no neighbors left
 - Look at next neighbor NN
 - Evaluate NN
 - If NN is Goal return and quit
 - If NN is better than S, $S := NN$
 - Reset neighbors

Hill Climbing Search

Steepest-Ascent-HC (S)

- Evaluate S; If Goal state return and quit
- $SUCC := S$
- Loop until a solution is found or no neighbors left
 - For all neighbors (NN) of S
 - Evaluate NN
 - If NN is Goal then return NN and quit
 - If NN is better than SUCC then $SUCC := NN$
 - If SUCC is better than S then
 - $S := SUCC$
 - Reset neighbors

Hill Climbing Continued

Stochastic-Hill-Climber (S)

- Evaluate S; If Goal state return and quit
- Loop until a solution is found or no neighbors left
 - Look at some random neighbor RN
 - Evaluate RN
 - If RN is Goal return and quit
 - If RN is better than S
 - $S := RN$
 - Reset neighbors

Hill Climbing Search

Problem: Local maxima or plateau...

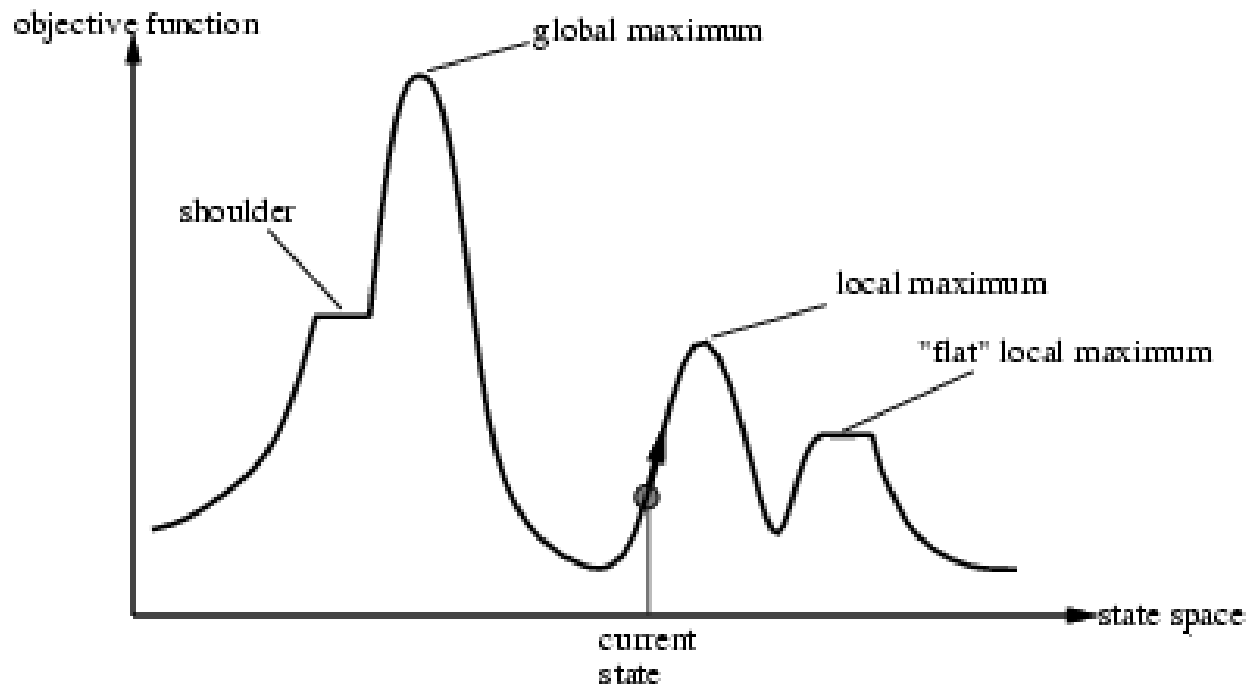

Problems with Hill Climbing

- Hill Climbing will get stuck at local maxima in the space
- Can get stuck on a “plateau”

Solutions

- Backtrack to earlier node and force it to go in a new direction
- Take a big jump to somewhere else in search space
- Simulated Annealing (Will study this next)
- Genetic Algorithms

Simulated Annealing Search

- Simulate the annealing process of creating metal alloys
- Start off hot, and cool down slowly which allows the various metals to crystallize into a global uniform structure
- If cooled too fast the metals crystallize in pockets
- If cooled too slowly, a uniform crystallization but wastes time

Simulated Annealing Search

- Use this idea to try to find global minimum
- Now finding minimum instead of maximum -- but it's the same
- **Wander** from the hill-climbing while system still hot
- **Reduce** to hill climbing as system cools

Properties: Simulated Annealing

- One can prove:
 - If T decreases slowly enough, then simulated annealing search will find a global optimum with probability approaching **unity**
- Widely used in VLSI layout, airline scheduling, etc

Details: Simulated Annealing

- The probability to move to a higher energy state in physics is

$$p = \frac{1}{e^{\Delta E/kT}}$$

where k is the Boltzmann constant

- Similarly, in SA (when finding the minimum), the probability to move to a state with a higher (worse) heuristic is:

$$p = \frac{1}{e^{\Delta E/T(t)}}$$

where

$\Delta E = (\text{value of current state}) - (\text{value of new state})$

$T(t)$ is the temperature schedule (a function of time t)

- Temperature monotonically decreases with time,
- Eventually T reaches 0 when the system becomes simple “hill descending”

SA Details When Maximizing

- The probability to move to a state with a lower (worse) heuristic function evaluation in SA is

$$p = e^{\Delta E/T}$$

where

$\Delta E = (\text{value of new state}) - (\text{value of current state})$

(The negation of the ΔE used when minimizing)

$T(t)$ is the temperature schedule (a function of time t)

- Temperature monotonically decreases with time
- Eventually T reaches 0 when the system becomes simple “hill climbing”

Simulated Annealing Algorithm

Simulated-Annealing (problem, schedule) From Russell and Norvig

Current := Initial-State(Problem)

for t := 1 to ∞ do

 T := schedule(t)

 If T = 0 then return Current

 Next := a randomly selected successor of Current

ΔE := Value(Next) - Value(Current)

 If $\Delta E > 0$ then

 “Always go to a better solution”

 Current := Next

 Else

 “Leave a better solution for a worse one with prob. $e^{-\Delta E/T}$ ”

 Current := Next only with probability $e^{-\Delta E/T}$

SA: Meta Heuristics

- If the solution is better:
 - Always move to it
- If the solution is worse but the slope up is shallow:
 - Try it out
- If the solution is worse but the slope is steep:
 - Don't try it out as readily (with an exponentially decreasing probability)
- As time goes on, don't try worse solutions as frequently
 - Again with an exponentially decreasing probability

SA Effects

- **At the beginning of the process** (when $T(t)$ is large)
 - The probability of moving to poorer states, or moving along a plateau is large.
 - So the space can be well searched
 - Local minimums can be passed over
 - Ignore steep ascents
 - This implies that you are in a deep valley, which is assumed to be good
- **As time increases**
 - The search gets trapped in one valley and gets stuck as $T(t)$ becomes small
 - The probability of getting out of the Valley is too small.
- **At this time**
 - SA becomes “hill descending”
 - Descends to the bottom of that valley - hopefully the global minimum

Genetic Algorithms

- A successor state is generated by combining two parent states
- Start with k randomly generated states (**population**)
- A state is represented as a string over a finite alphabet (often a string of 0s and 1s)
- Evaluation function (**fitness function**). Higher values for better states.
- Produce the next generation of states by selection, crossover, and mutation

Genetic Algorithms

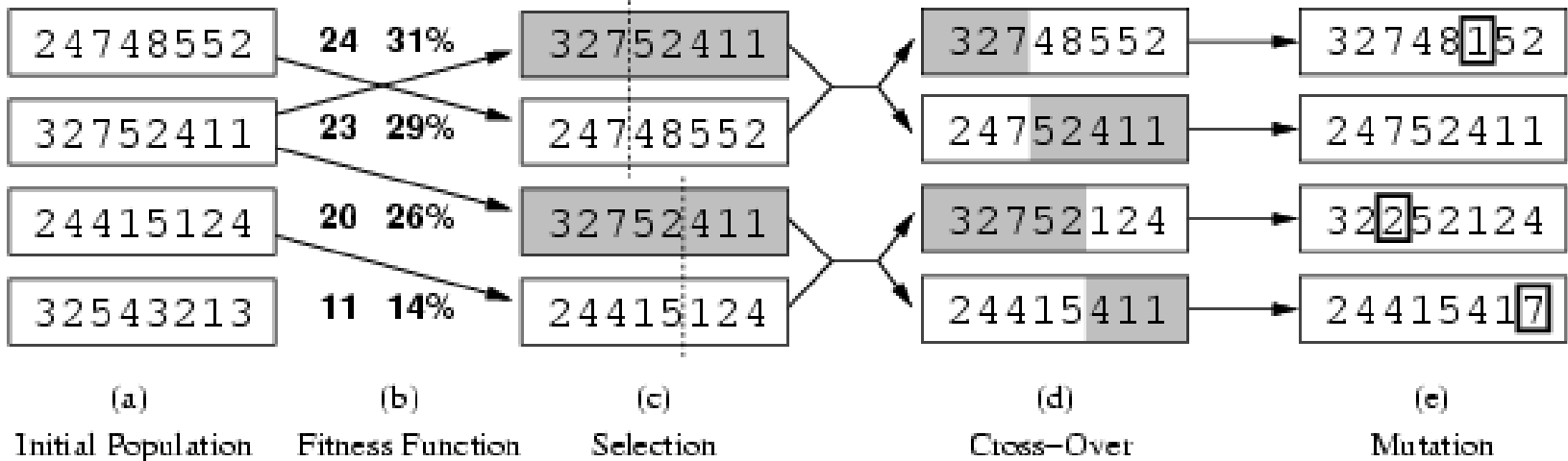

- **Fitness function:** Number of non-attacking pairs of queens
(min = 0, max = $8 \times 7/2 = 28$)
- $24/(24+23+20+11) = 31\%$
- $23/(24+23+20+11) = 29\%$ etc

OR Graphs vs. AND-OR Graphs

- In the previous search techniques, Solution can be found down any path independent of any other path
- This is called an **OR** graph
- However, there may be sub-goals that must **all** be solved for a solution to be found
 - Each sub-goal is its own sub-tree
 - All sub-trees must have its own end state found if the path is to be considered satisfied
- This is called an **AND-OR** graph

Example of an AND-OR Graph

- Getting software to accomplish a task

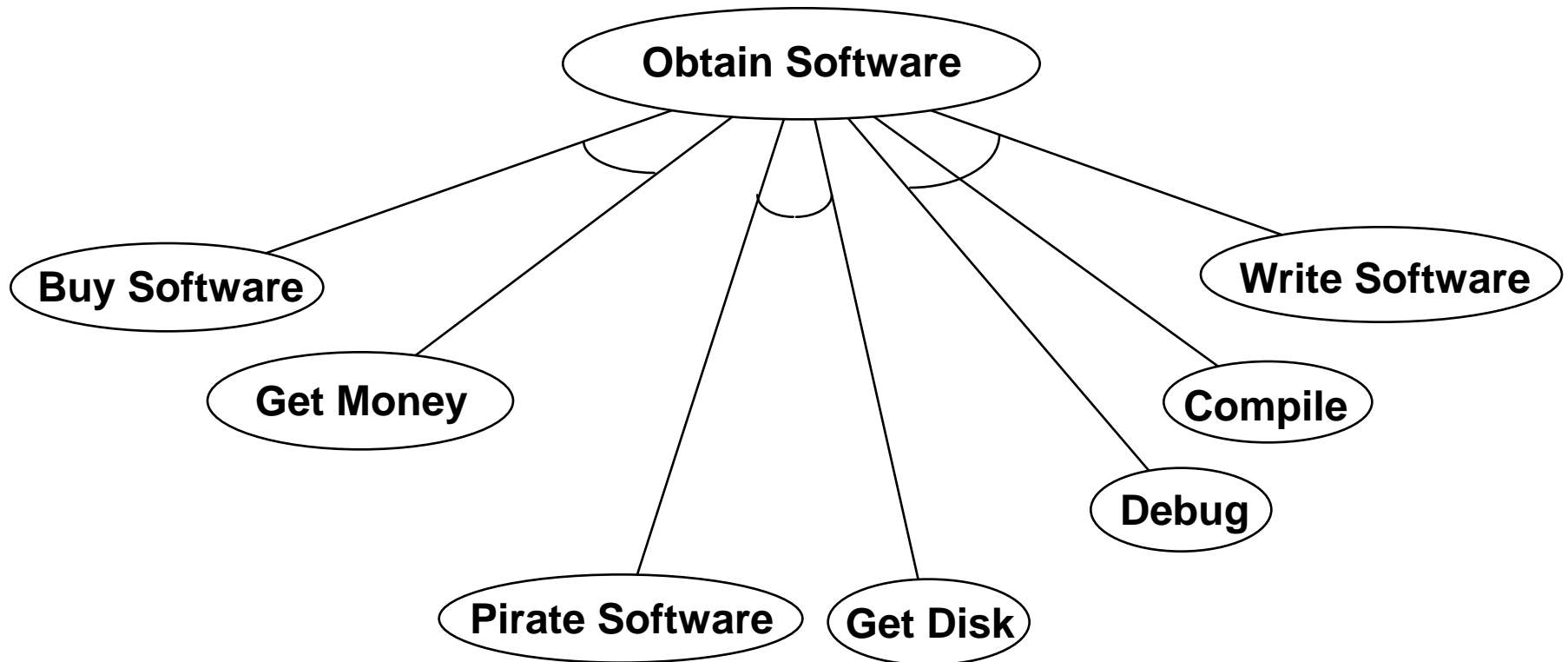

Problem Reduction Algorithm

- **Initialize** the graph to the starting node
- Until the starting node is labeled SOLVED or its cost $>$ FUTILITY do:
 - Start at initial node and traverse best path
 - Accumulate set of nodes on path not expanded or labeled SOLVED
 - Pick an unexpanded node and expand
 - If no successors, node cost = FUTILITY
 - Add successors to graph after computing the heuristic f for each
 - If $f = 0$ for any node mark node as SOLVED
 - Propagate change back through path
 - If child is an OR child and is SOLVED mark parent as SOLVED
 - If AND children are all solved, mark parent as SOLVED
 - Change the estimate of f as determined by children
 - As we back up the tree, change current best path associated with each node (on the original best path) if updated f values warrant it

Example of Problem Reduction (AO*)

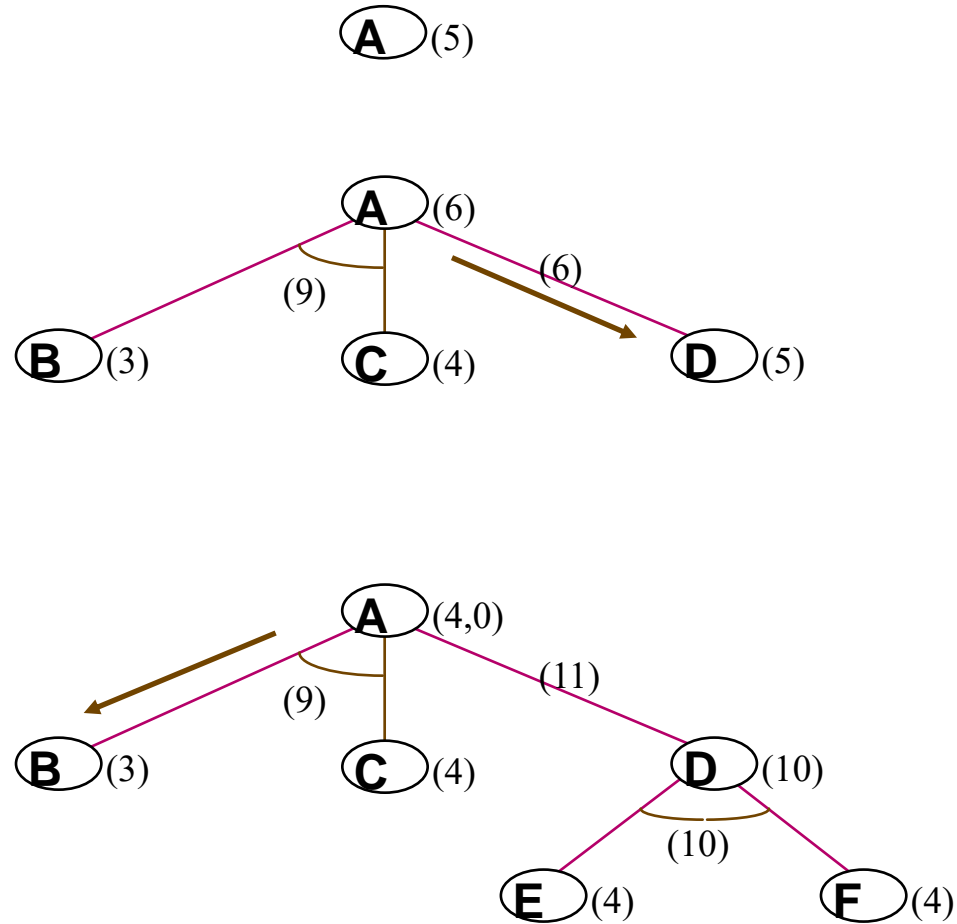

When you calculate costs, remember to use the cost PLUS the depth

Example of Problem Reduction (AO*)

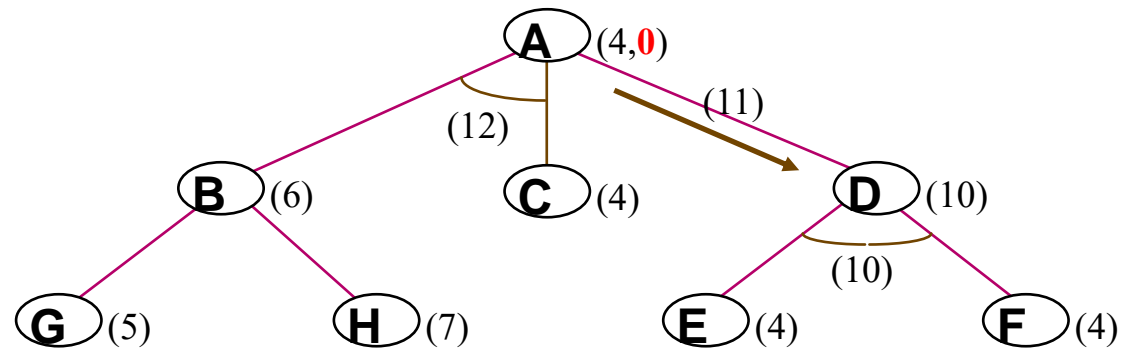

Interacting Sub-goals

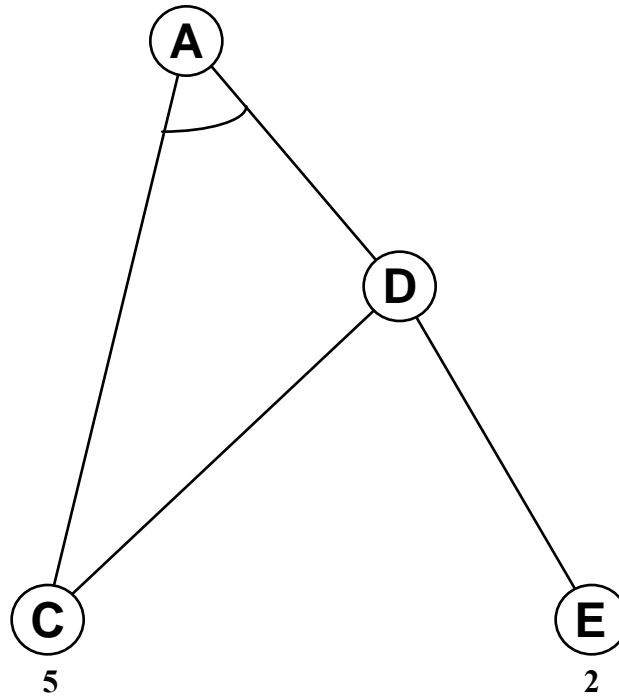

Branch and Bound

- If we know that current path (branch) is already **worse** than some other known path:
 - **Stop** Expanding It (Bound).
- Have already encountered Branch and Bound:
 - A* stops expanding a branch if its heuristic value h becomes larger than some other branch

Constraint Satisfaction Problems and Branch and Bound

- Problems where there are **natural constraints** on the system (fixed resources, impossibility conditions, etc.)
- Constraints: Handled by **Branch and Bound** technique
 - Branch out in your normal search pattern
 - Stop expanding a branch if it fails a constraint (backtracking may occur when that happens)
- Trivial example: Missionaries and Cannibals
 - Do not continue to search along a branch if the Cannibals have just eaten some (or all) of the Missionaries